

E-1a	1651	400	16	x 1	1/1
E-1b	1651	400	16	x 1	1/1
E-2	670	380	16	x 1	1/1
E-3	670	380	16	x 1	1/1
E-4	670	365	16	x 1	1/1
E-5	670	365	16	x 1	1/1
E-6	526	364	16	x 2	1/1
E-7	534	349	16	x 1	1/1
E-8a	547	140	16	x 1	1/1
E-8b	547	140	16	x 1	1/1
E-9a	547	336	16	x 1	1/1
E-9b	547	336	16	x 1	1/1
E-10	664	378	16	x 1	1/1
E-11	670	186	16	x 1	1/1
E-12	670	24	18	x 4	1/1
E-13	1632	684	3	x 1	1/1
E-14	545	225	4	x 2	1/1

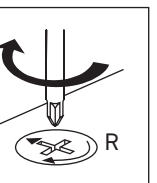

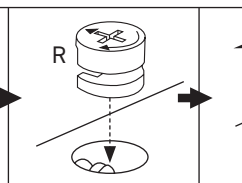

1

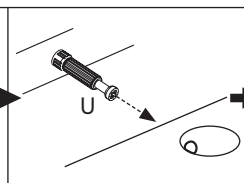
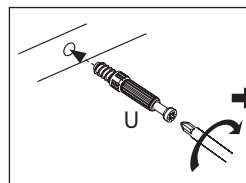
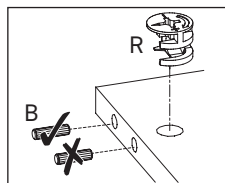
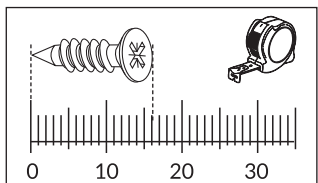
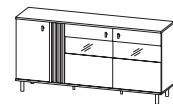
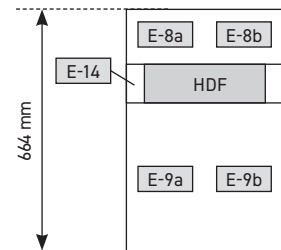
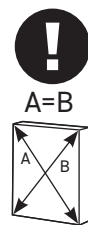
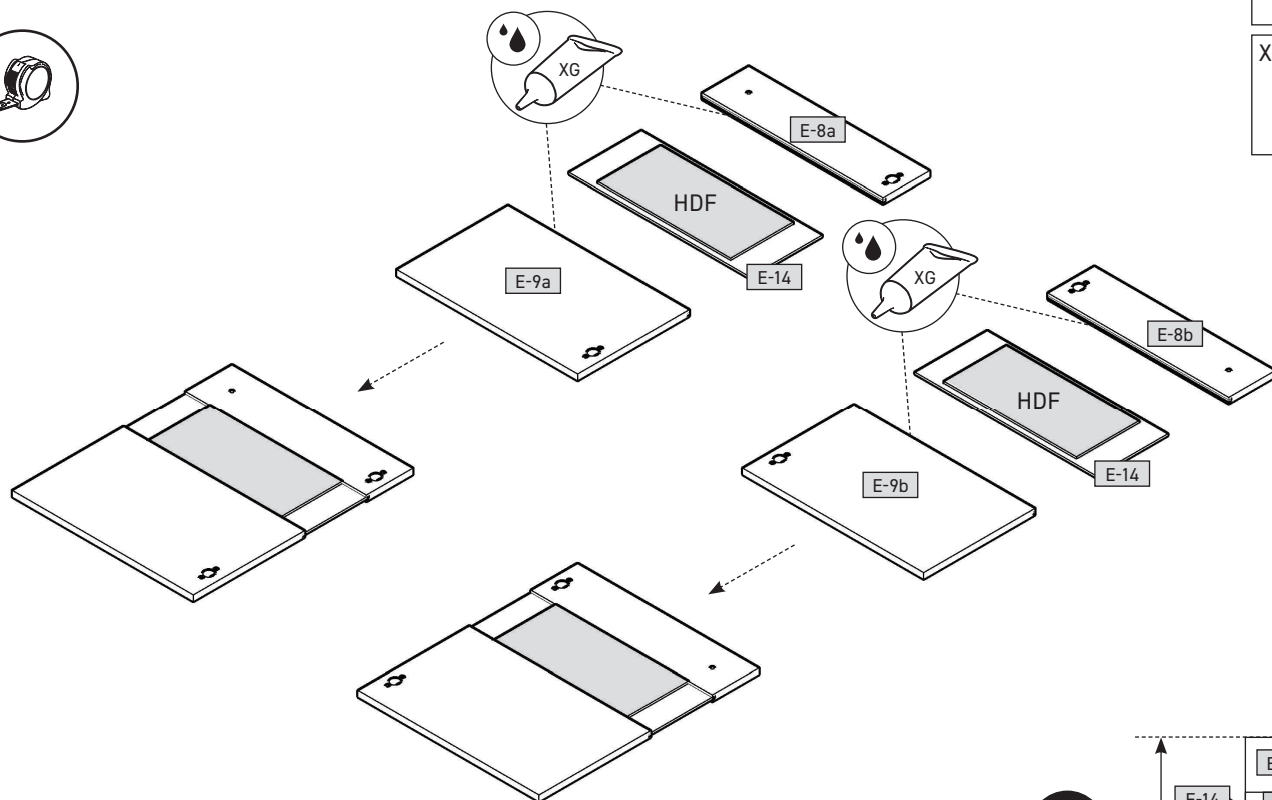
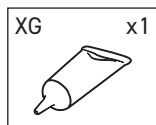
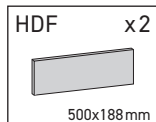
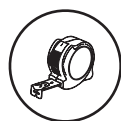

2

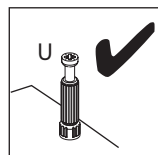
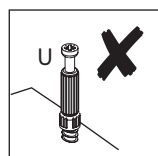
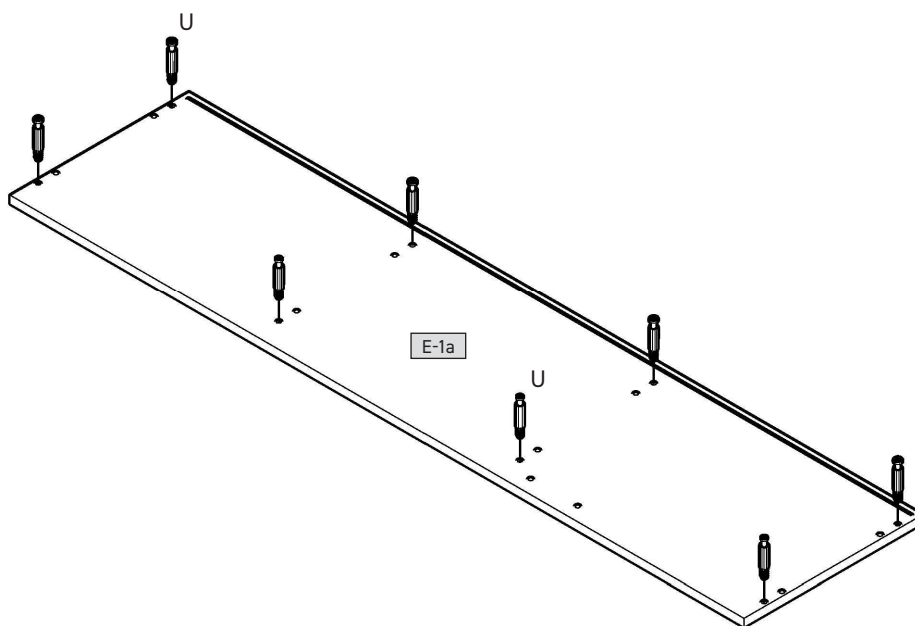
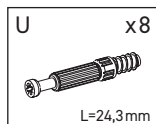

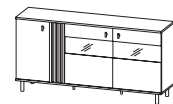

3

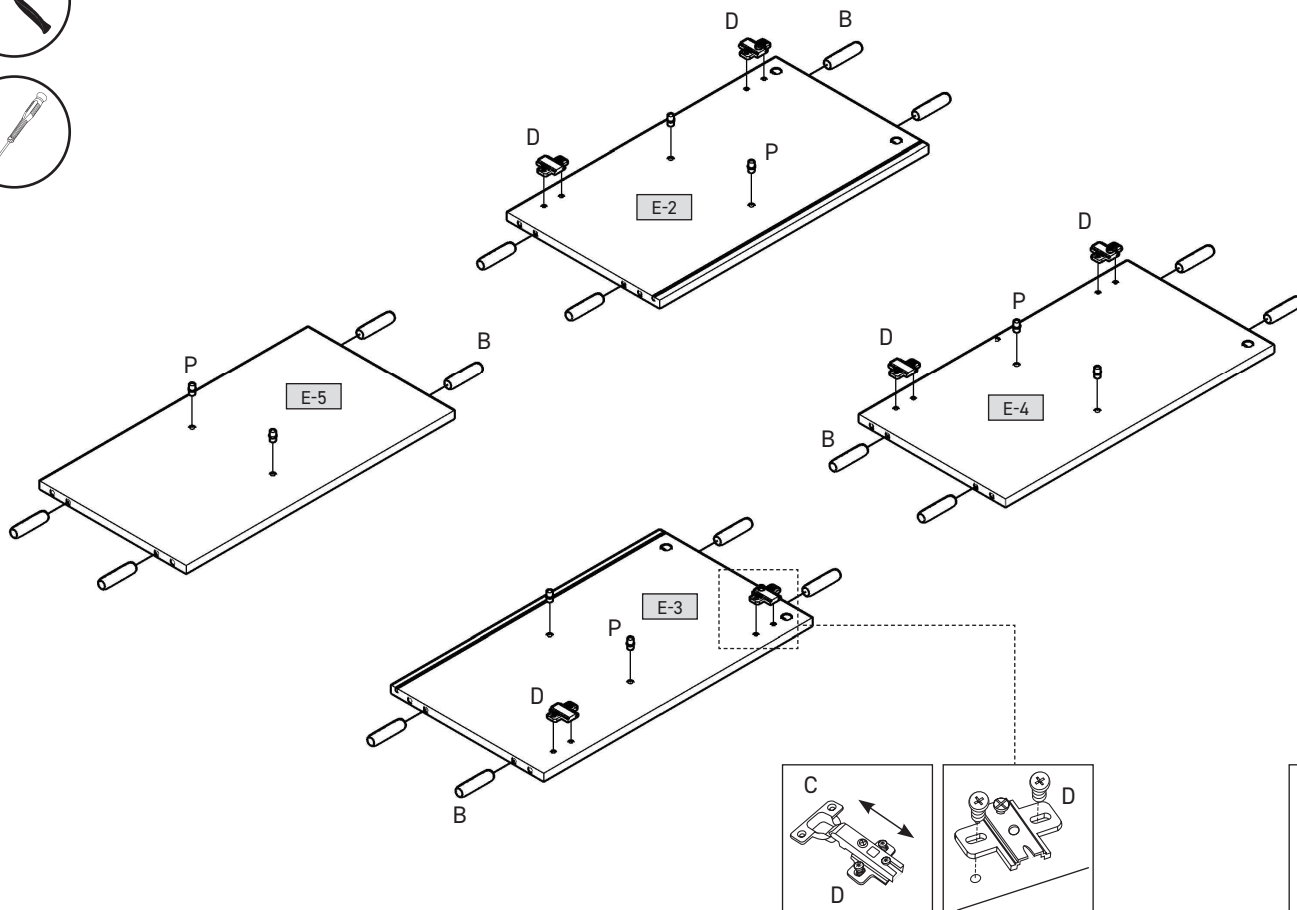
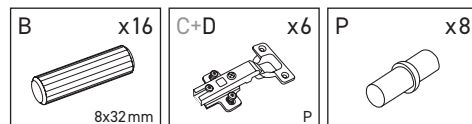

4

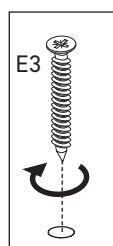
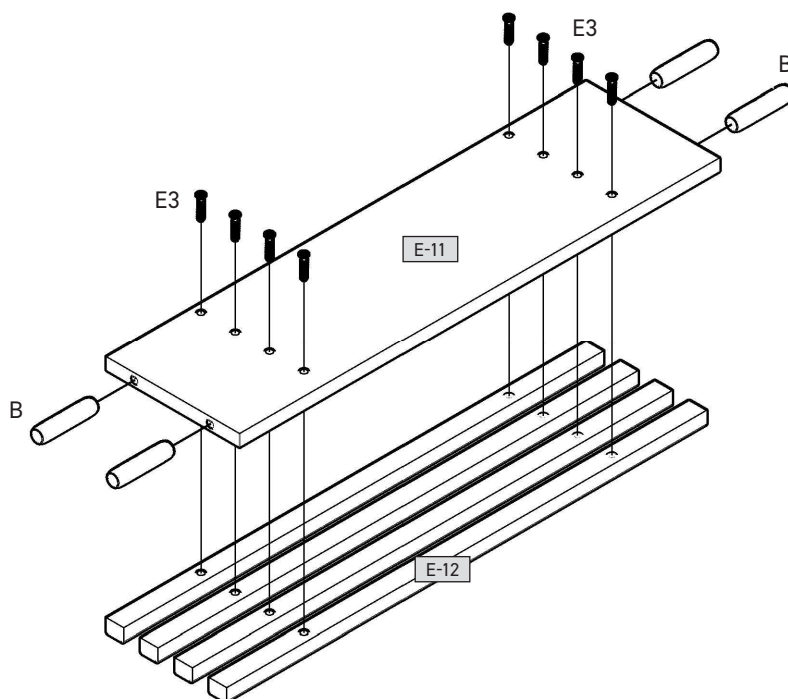
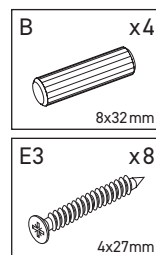

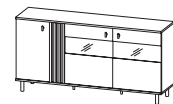

5

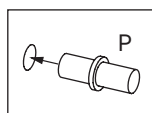
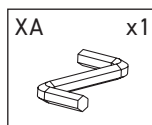
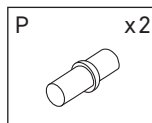
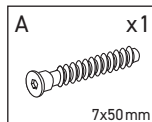
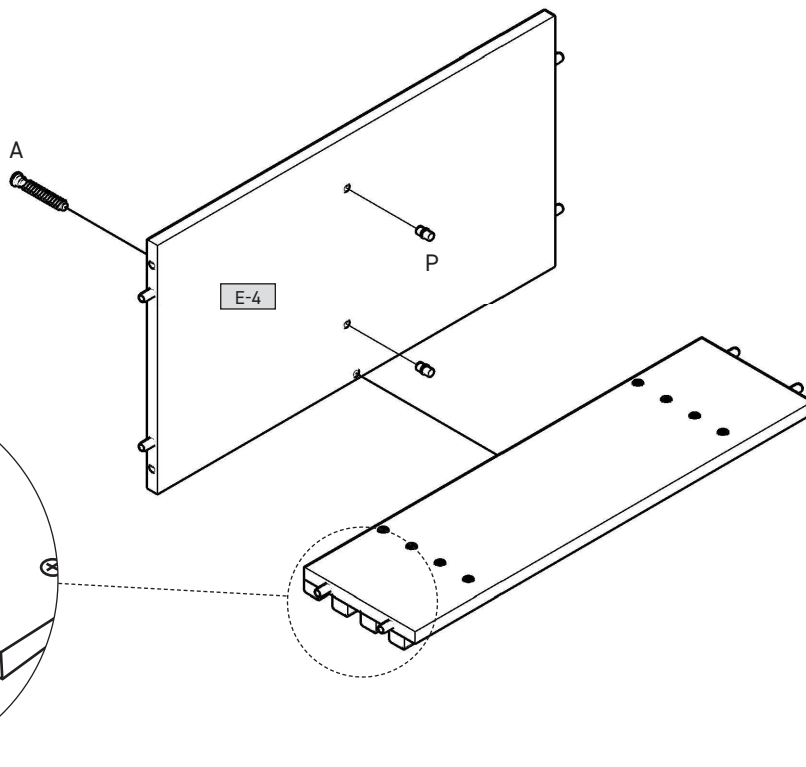
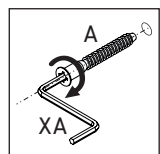

6

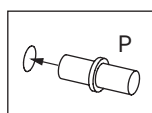
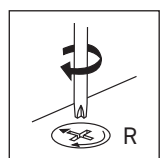
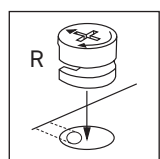
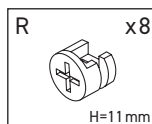
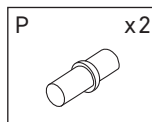
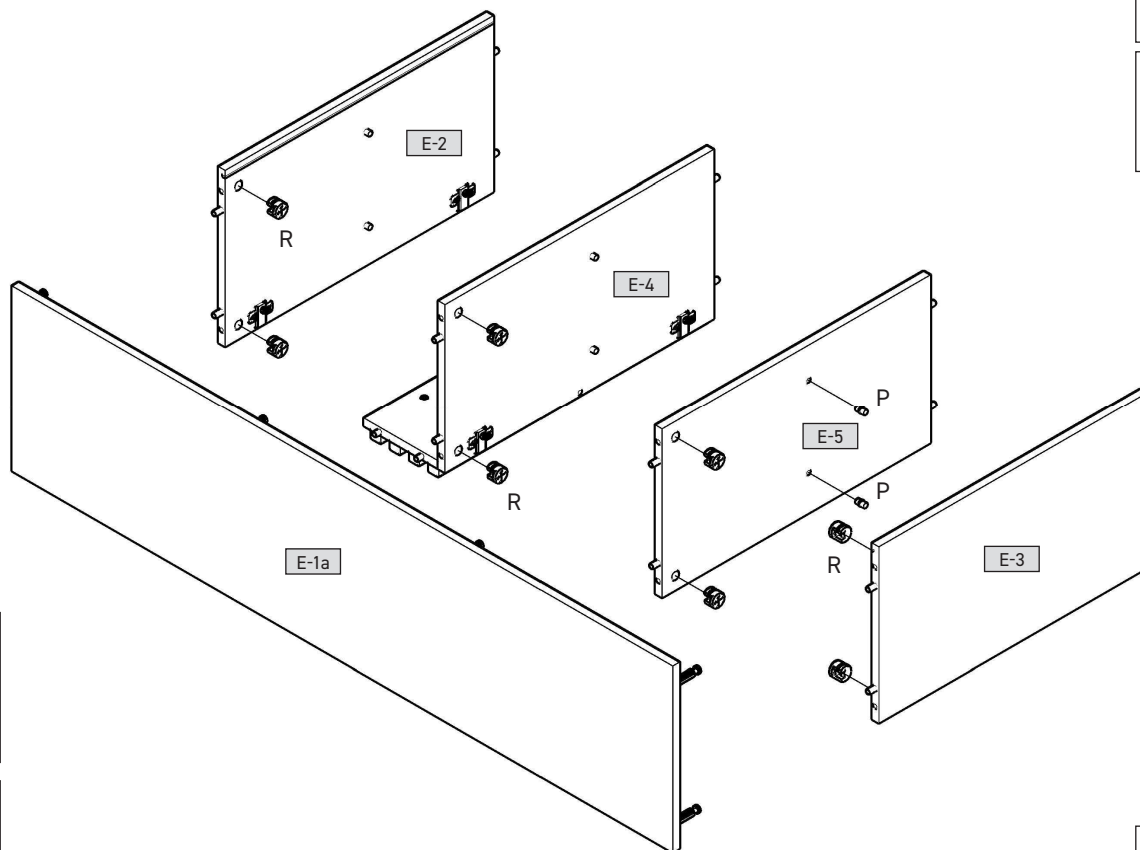

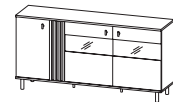

7

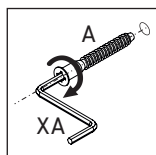
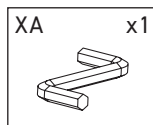
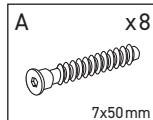
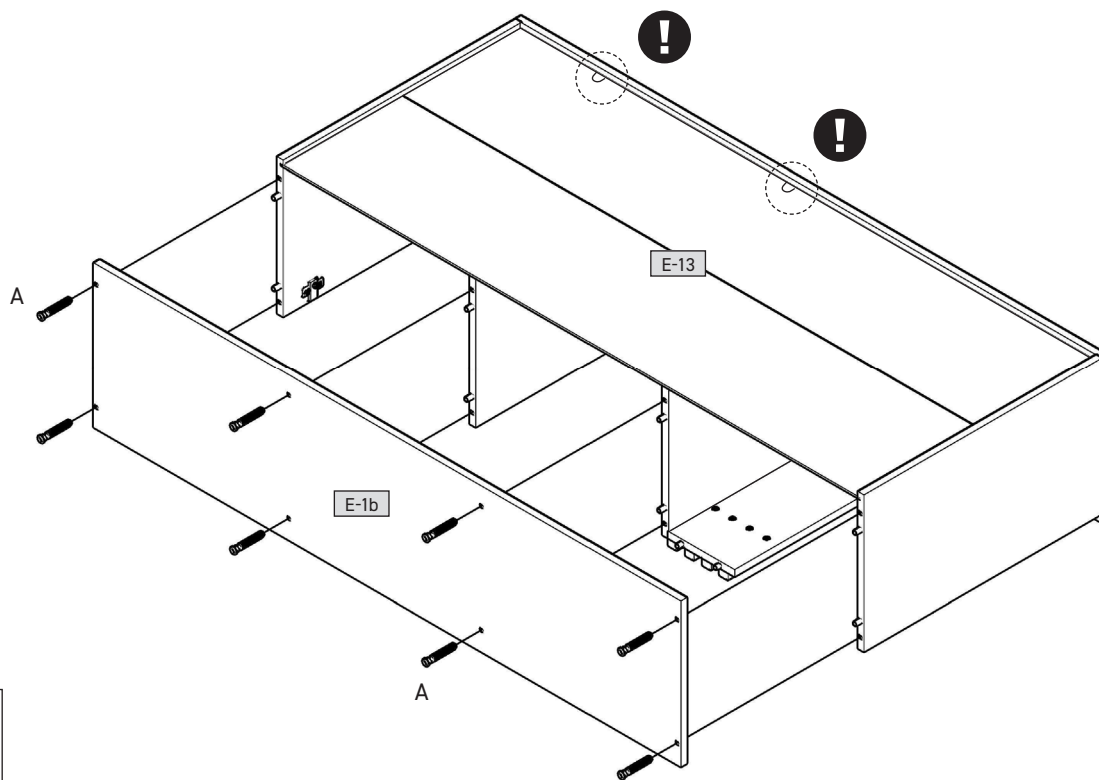

8

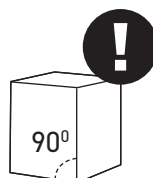
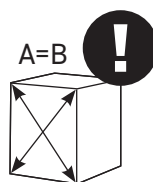
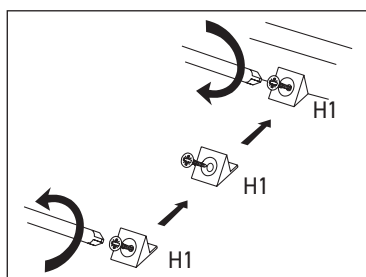
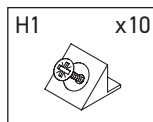
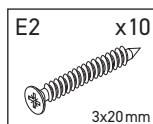
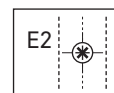
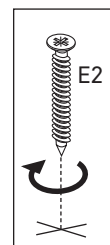
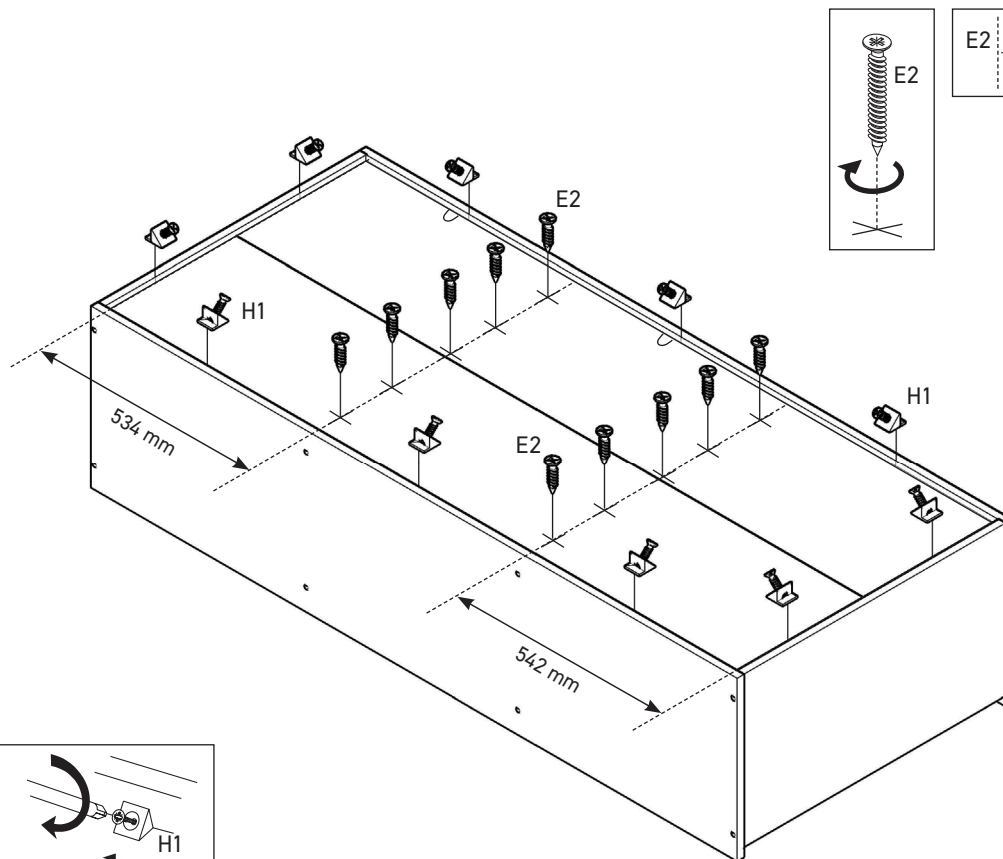

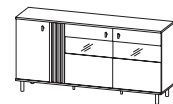

9

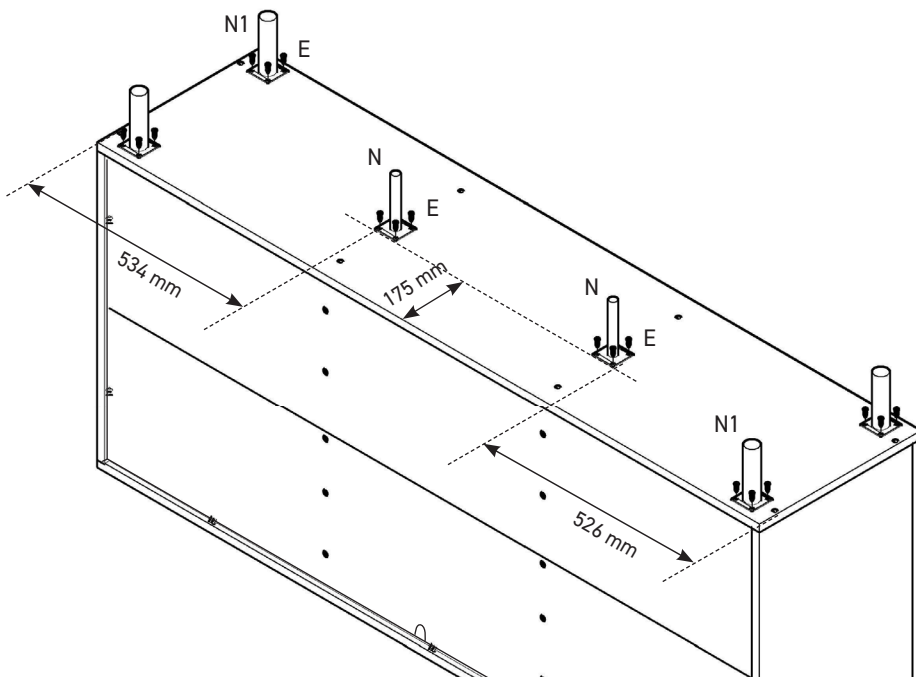

- E** x24
3,5x13mm
- N** x2
Ø18 / H=120mm
- N1** x4
Ø30 / H=120mm

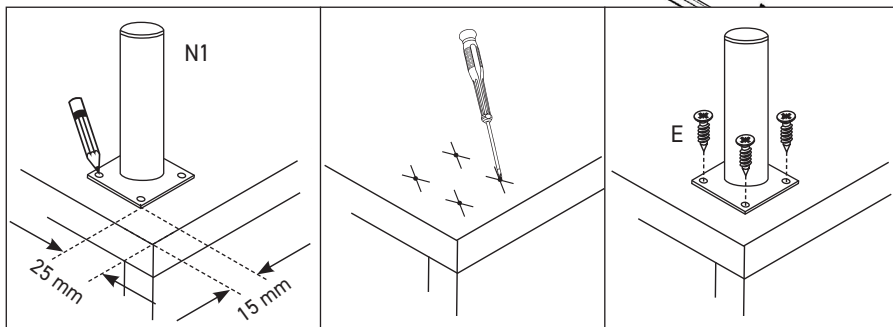

10

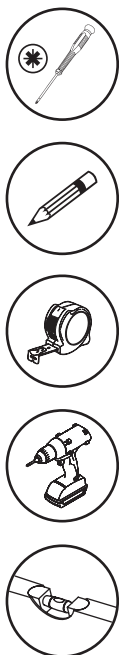

- E** x1
3,5x13mm
- W1** x1

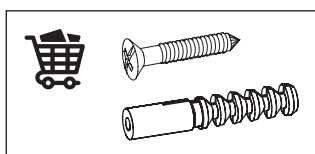
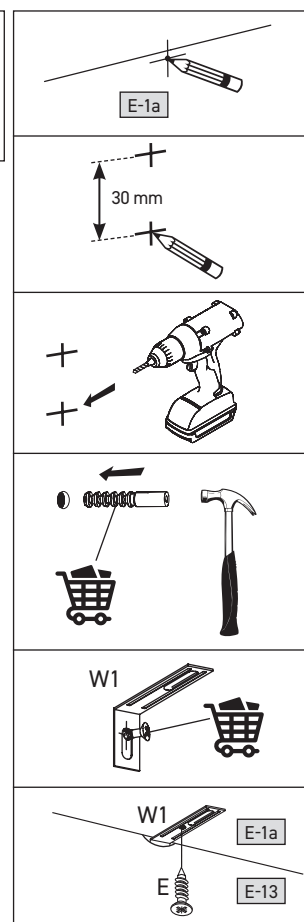
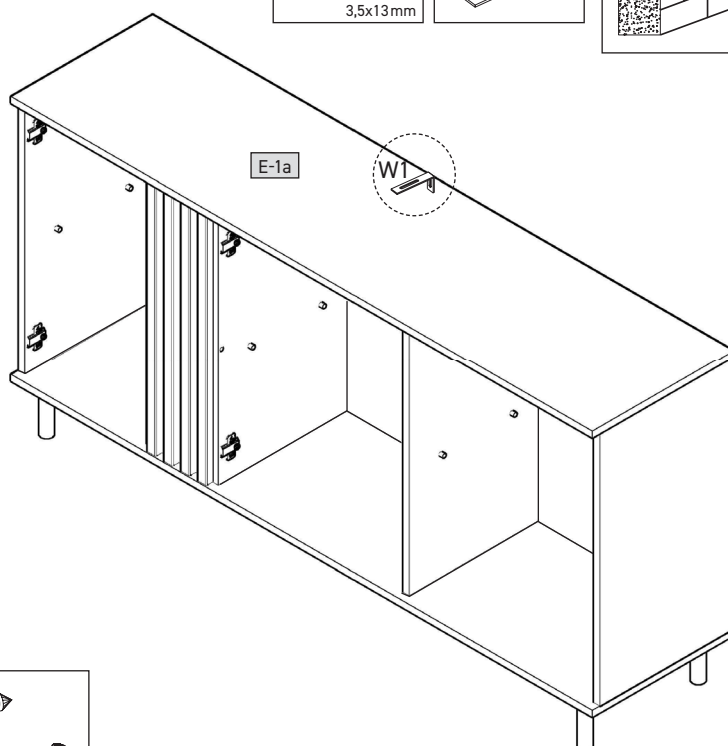
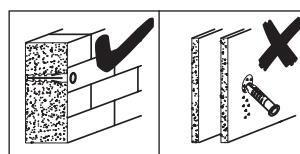

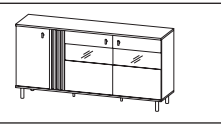

11

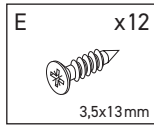
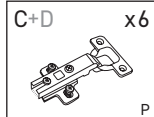
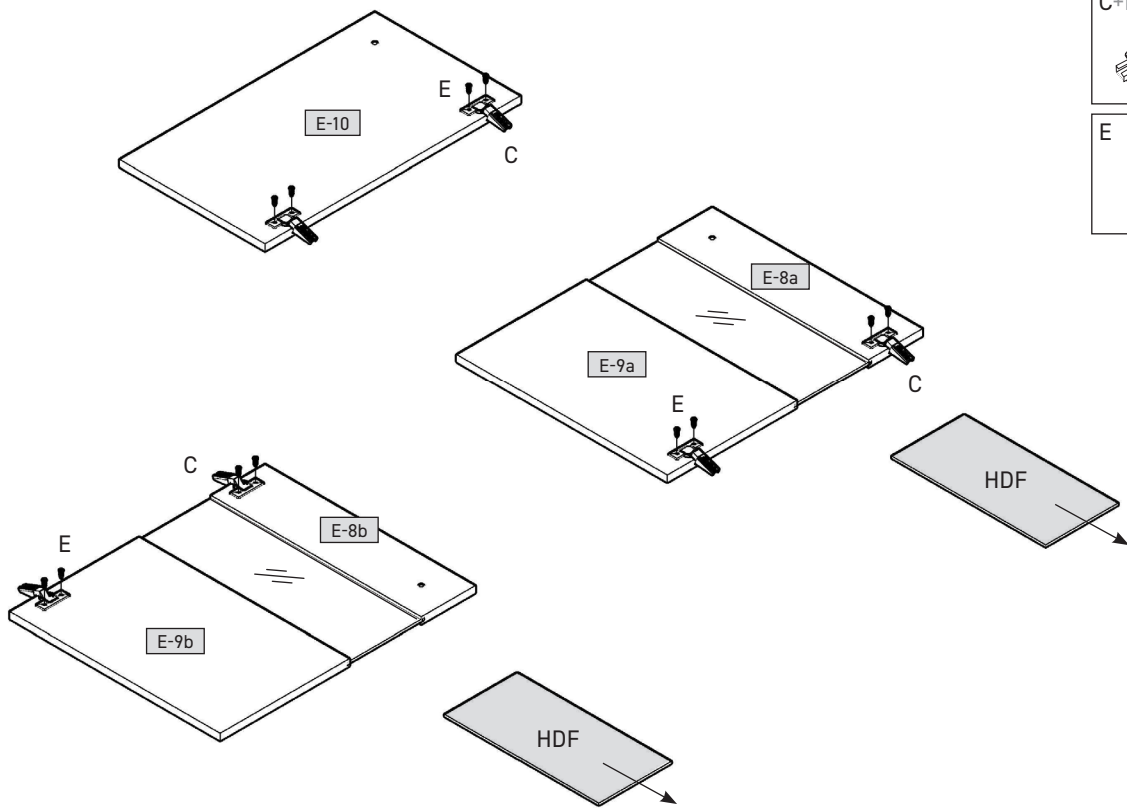
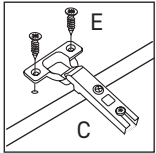

12

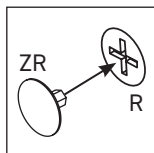
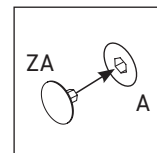
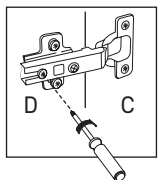
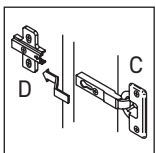
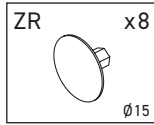
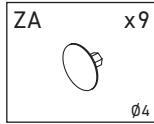
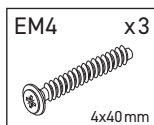
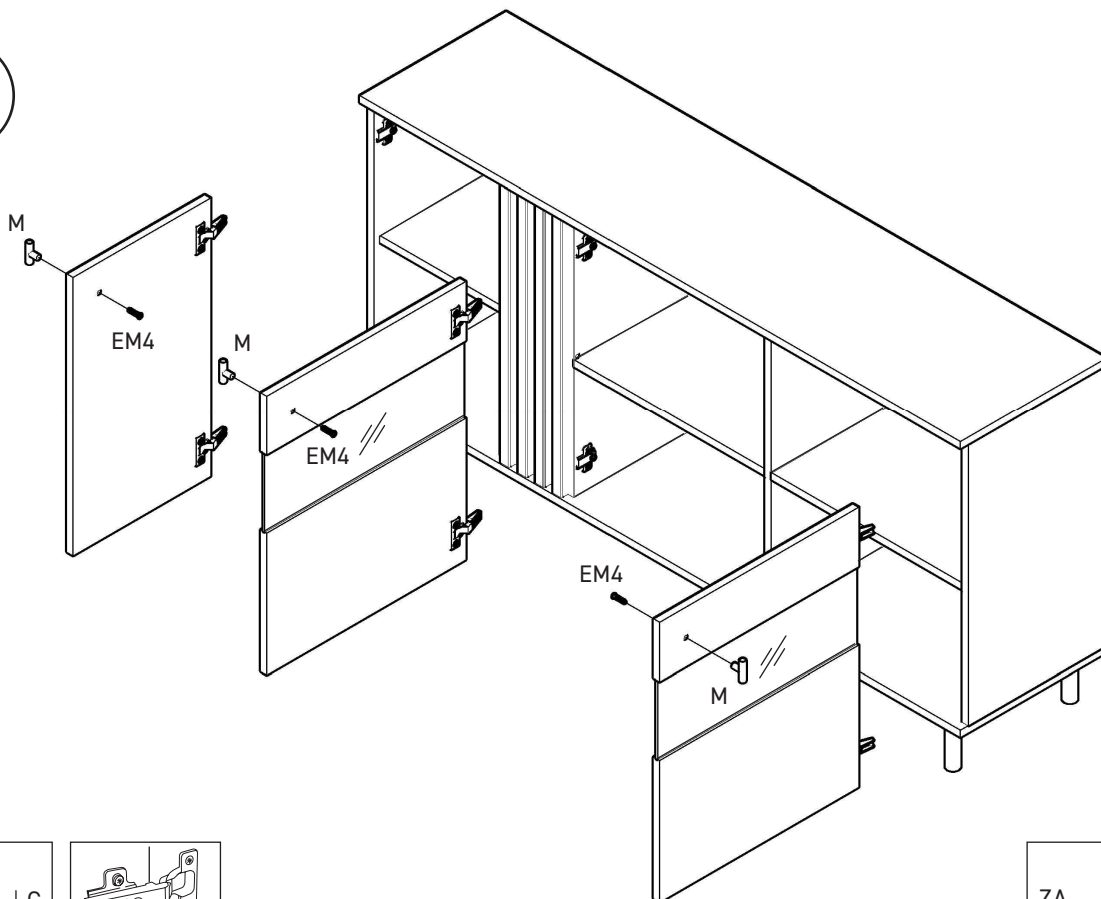

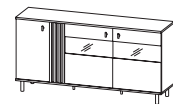

13

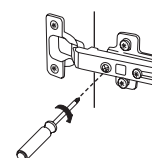
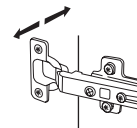
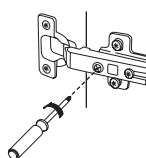
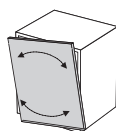
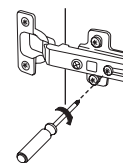
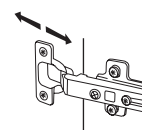
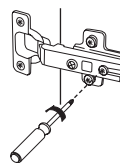
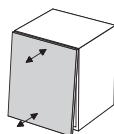
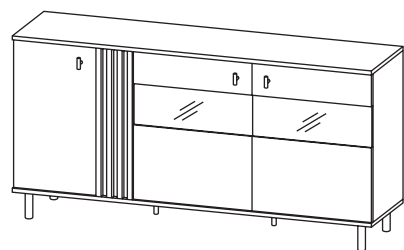
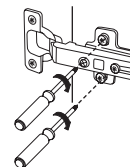
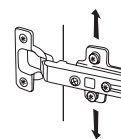
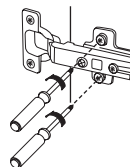
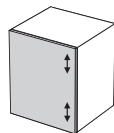

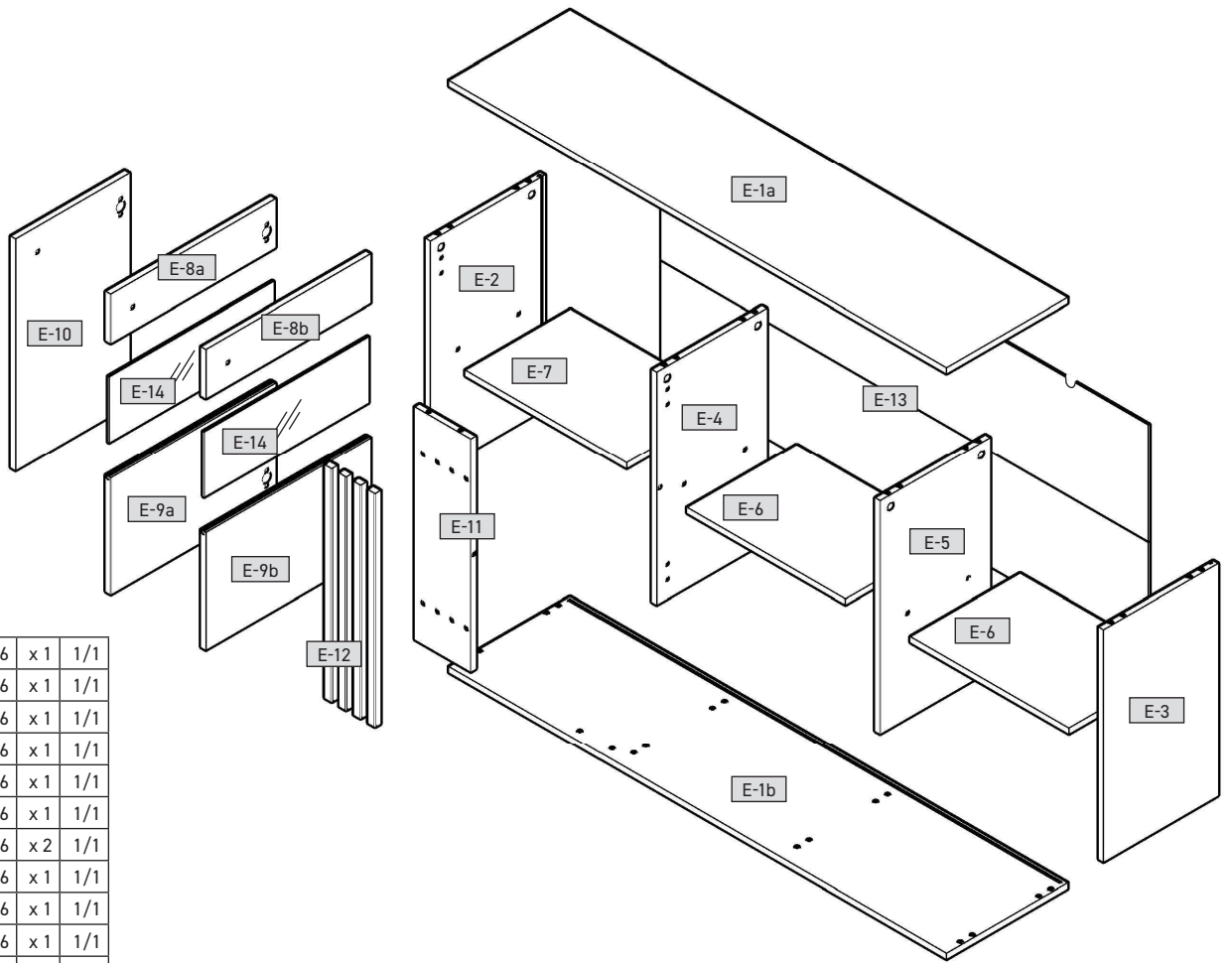
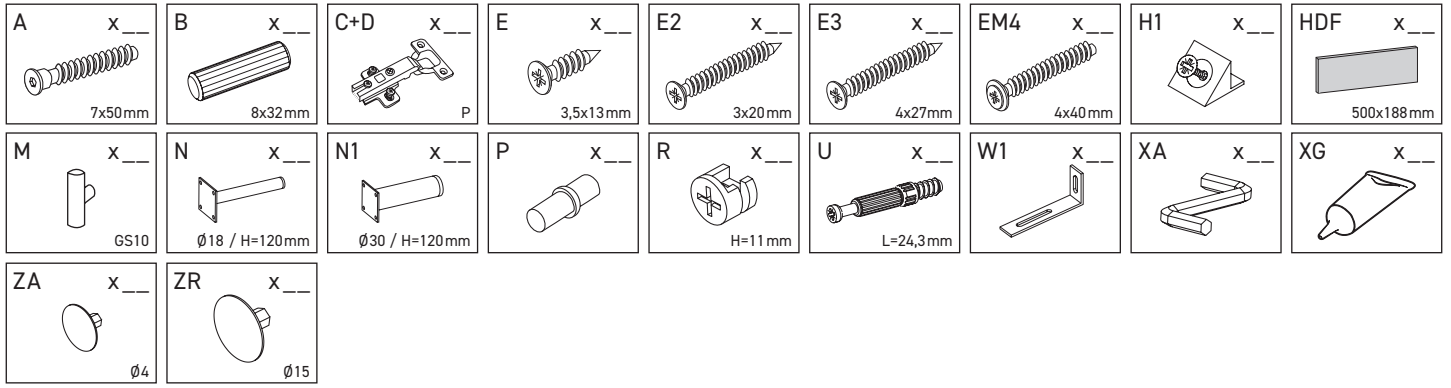

E-1a	1651	400	16	x 1	1/1
E-1b	1651	400	16	x 1	1/1
E-2	670	380	16	x 1	1/1
E-3	670	380	16	x 1	1/1
E-4	670	365	16	x 1	1/1
E-5	670	365	16	x 1	1/1
E-6	526	364	16	x 2	1/1
E-7	534	349	16	x 1	1/1
E-8a	547	140	16	x 1	1/1
E-8b	547	140	16	x 1	1/1
E-9a	547	336	16	x 1	1/1
E-9b	547	336	16	x 1	1/1
E-10	664	378	16	x 1	1/1
E-11	670	186	16	x 1	1/1
E-12	670	24	18	x 4	1/1
E-13	1632	684	3	x 1	1/1
E-14	545	225	4	x 2	1/1